

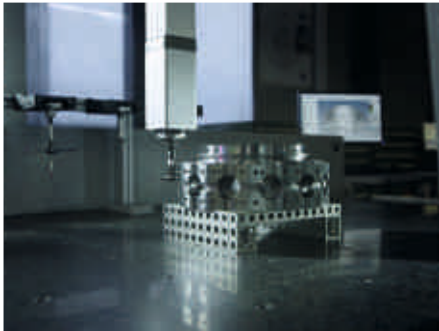

Machine tools

The complete machine range for turning, milling and grinding

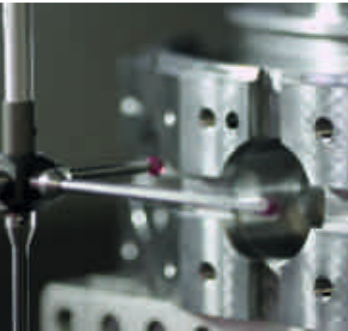

Model range 8/2019



Tradition in Mechanical Engineering



4

PD series:

Ultra-Precision Lathe for micro-finishing and hard-turning



6

MicroTurn:

Turning-Milling Centre for complete precision machining AND micro-finishing



8

TC series:

Powerful Universal Lathe for high cutting performance



10

TTS series:

High Productive Turning Center for simultaneous machining with up to three turrets



12

U-Compact-Line series:

Travelling-Column Machining Center with 3, 4 or 5-axes-machining, the entrylevel to the superior milling class



14

U-Advanced series:

Travelling-Column Machining Center with up to 5 axes, for high-end applications in the 5-axes simultaneous machining and the series production



16

VC-3A series:

High-Speed Machining Center for demanding tasks in the workshop and in tool and mould making



18

VC-5A series:

5-Axes Precision Machining Center for large workpieces



20

Bar feeders:

Specially for SPINNER CNC-Lathes designed bar-loading system



21

SM100:

THE Universal Toolgrinder for each workshop

22

Automation:

Integrated standard solutions with robot or individual solution, ALL FROM ONE SOURCE

Turning

We have been perfecting and improving our machine tools for more than 50 years. Today, more than 550 employees in the SPINNER GROUP complete more than 1,000 machine tools each year. SPINNER machines are successfully being used in more than 60 countries of the world.

In order to satisfy your requirements, we offer a wide range of Turning Machine and Machining Centre products. Tens of thousands of customers throughout the world trust in our CNC machine tools.

Our machine tools are always used where a particular demand in precision and reliability is required. Innovation and practical solutions in detail are guaranteed by our extensive construction department. We manufacture all important components and assemblies ourselves in our production plants in order to be able to supply you with machine beds, guideways, spindles and turrets that are perfectly matched to one-another.

Our machine tools are sophisticated seriesbuilt products manufactured at a high level. High precision standards in all areas of the production and assembly ensure for the optimum constant quality of our products. Each machine is subjected to a strict final inspection of all parameters.

We supply turnkey projects with automation for large-scale production. In order to ensure that the use of our machine tools is successful, we offer training courses for the operation, programming and maintenance of our systems.

Our service hotline deals with technical queries concerning the programming and repair of your SPINNER machine tools at any time and at short notice.

Place your trust in our products as well and let us know what we can do for you.



Milling



Grinding

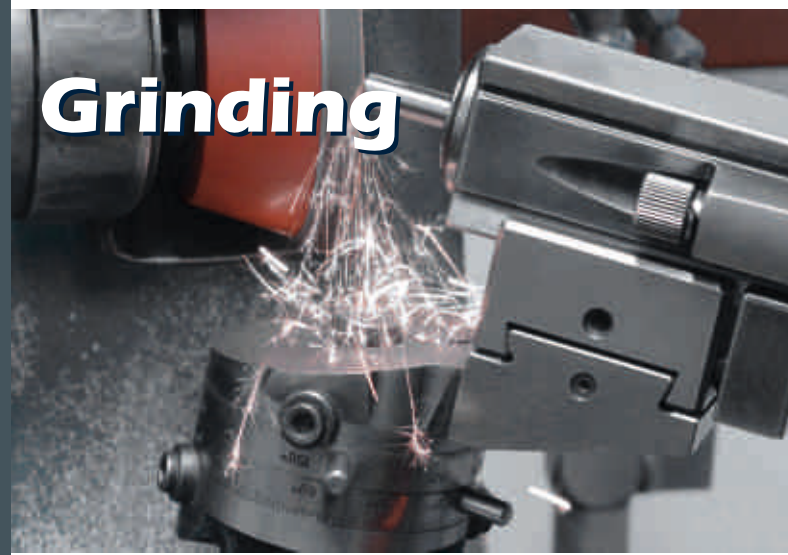

Automation



PD

SPINNER
PD-CNC

Micro-finishing and diamond turning
Hard turning > 60 HRC
Perfect surface finishing

Ultra Precision Lathes



- Most compact dimensions among precision turning machines
- Hardened and ground precision sliding guideways with high vibration damping
- 0,1 μm resolution linear scales
- Micro-turning in sub μm -range
- The most precise spindles on the market with roundness < 0,1 μm
- Best slide positioning repeatability
- High accuracy process reliability

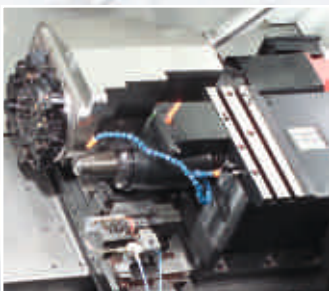

Turret and sub spindle



Turret and tailstock



Linear tooling

Optimal geometric tolerances
 Precise clamping devices
 Made in Germany

For Micro-finishing and Hard-turning

Wide range of standardized auto-loading available by robots or special made solutions according to customers workpieces, or bar feeder



Part catcher

Model sizes

	Collets/Chucks	Max. workpiece sizes
PD32	32/125 mm	Ø ~120 x 250 mm
PD42	42/140 mm	Ø ~120 x 250 mm

Microturn

Micro-finishing
Hard-turning
Universal machining

Turning-Milling Centre for complete machining



- In X 600mm and Z 350mm moveable spindles for high rigid and optimised positioning <math>< 1 \mu\text{m}</math>
- Direct measurement system for all axes
- Static linear table for standard linear tooling or special tools
- High precision motor spindles "Made by SPINNER" of various sizes
- High-precision hard-turning

Linear tooling system for micro-finishing in combination with turret and Y axis for universal machining.

Expandable to a 5-axes Turning-Milling centre for machining all 6 workpiece sides.



Microturn

With Y axis
With B axis and milling spindle
Available with sub-spindle

AND micro-finishing

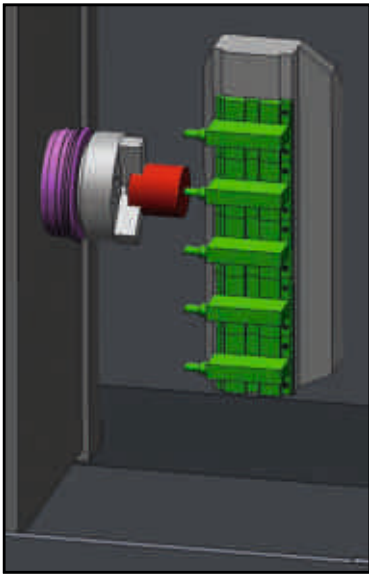

L-Version

Spindle with high precision positioning in X1/Z1 and linear tooling as optimal rigid hard-turning and micro-finishing machine

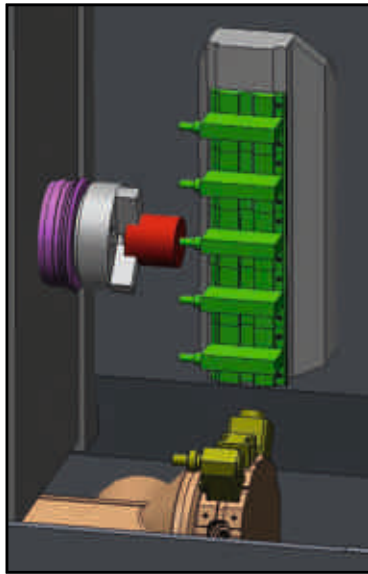

LT-Version

With additional turret with driven tools and Y1 axis in the lower part of the workspace



LTB-Version

With additional milling spindle with Y2 and B axis in the upper part of the workspace and with tool magazine up to 72 tools

Unique combination of universal soft machining up to 5-axes Turning-Milling AND high-precision hard-turning machine in a single machine concept.

LTBS-Version*

With two spindles on symmetrically positioned slides X2/Z2, also for simultaneous machining with sub-spindle

* Starting first quarter 2019

Strokes

	X axis	Y axis	Z axis	B axis	Turret
L-Version	600 mm	-	350 mm	-	-
LT-Version	600 mm	+/- 50 mm	350 mm	-	12 x BMT45
LTB(S)-Version	600 mm	+/- 50 mm	350 mm	+/- 180°	12 x BMT45

TC

Universal
Stable
Compact

Powerful Universal Lathes



■ Hardened and ground sliding guideways for best vibration damping

- Solid sliding guideways with high damping
- Monoblock rigid casting design of machine body
- Tailstock or sub spindle
- Optional Y axis and driven tools
- Modern motor spindles (up to 85 mm)
- Gearboxes for high torques (from 110 mm)
- Latest control system Siemens 840D or Fanuc 32i



Available with automation



Turret VDI150
of TC800-MC



Y axis fully integrated in
the machine bed

Reliable technology
High precision
Durable

Turning length from 400 up to 1500 mm



Machine bed TC600



Model sizes

	Bar material up to	Chucks	Max. Turning length
TC300	52/65 mm	160/210 mm	350 mm
TC400	52 mm	160/210 mm	500 mm
TC600	65/85 mm	250 mm	650 mm
TC800	85/110/175 mm	250/315/400/500 mm	900-1500 mm

TTS

Powerful
Highly dynamic
Highly productive

Simultaneous machining from bar material or with automation

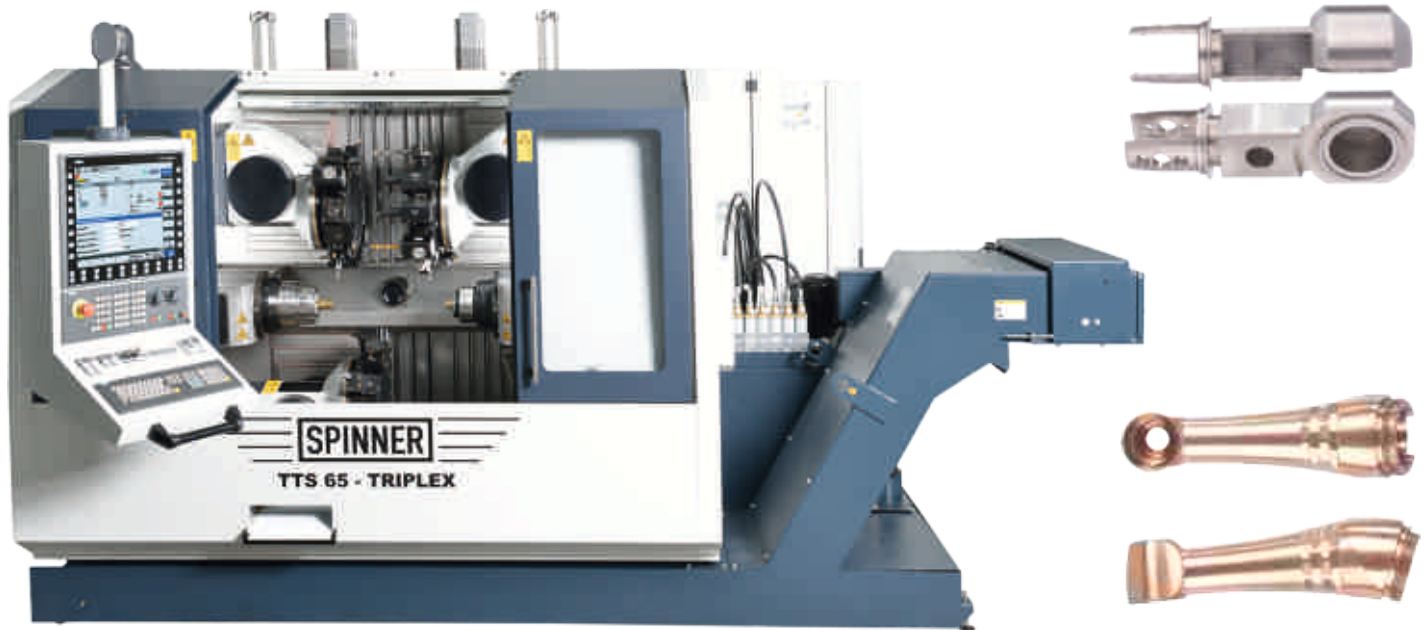

- THE productive turning solution for bar machining or with automation
- Reduction of cycle time by simultaneous operations with up to 3 turrets
- TRIPLEX-Version (3 turrets) with 2 Y axes
- Each turret can work either on the main spindle or on the sub spindle
- Increased cutting performance by integrated passive vibration damping
- Perfect covers for guideways
- Integrated motor spindles with water cooling

Rigid turret made by SPINNER
with high-precision toolholders
BMT45 or with toolholders
VDI25



Passive structure damping
 Increased cutting performance
 Made in Germany

For complex turning AND milling parts

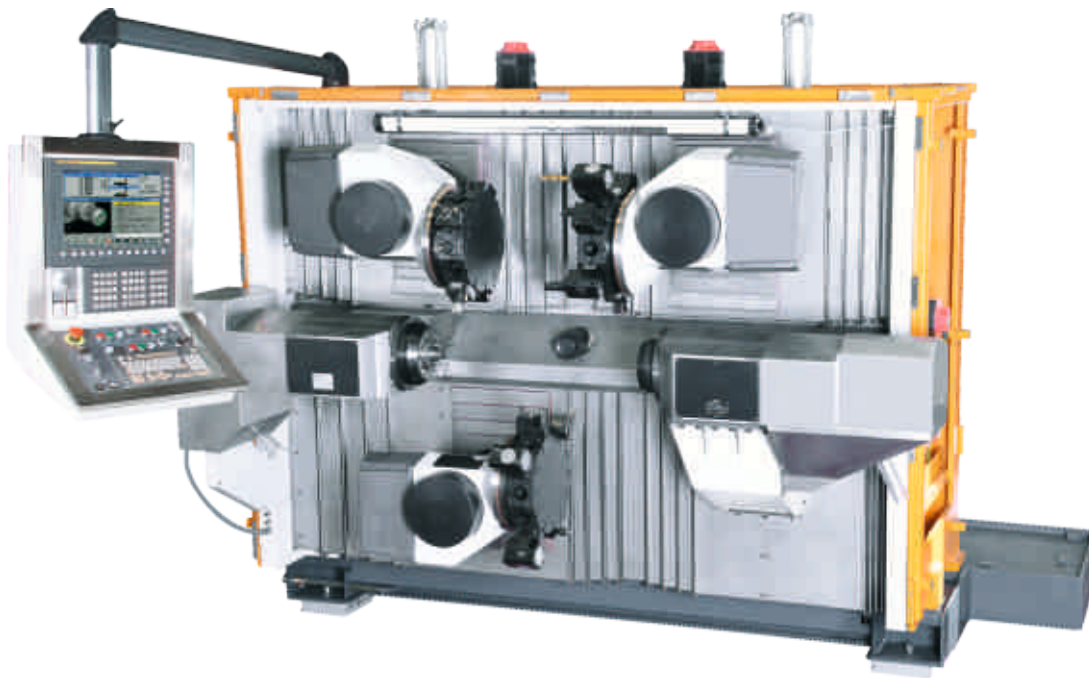

- Perfect working area guarding
- Perfect free chip fall

As all turrets can work either on the main spindle or on the sub spindle there are lots of machining possibilities for optimised turret utilisation.

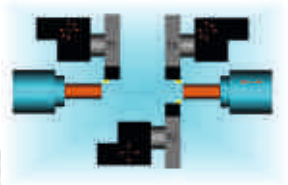

Turret 1 on left spindle, turret 3 on right spindle, turret 2 on left or right spindle

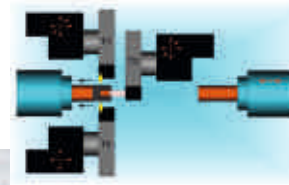
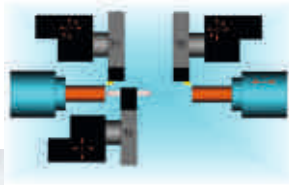

All turrets are working simultaneously on one spindle

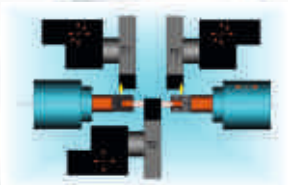
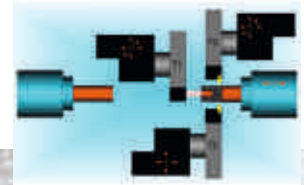

Turret 2 is drilling on both sides or turret 2 is used as steady rest

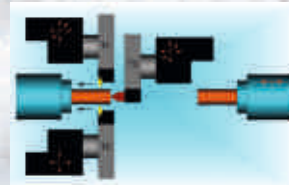
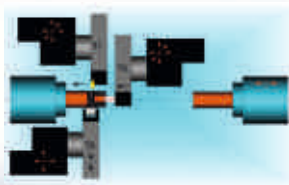

Turret 1 or 3 is used as tailstock

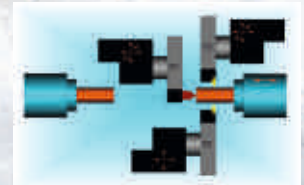

U-Compact

Universal
Compact
Affordable

Universal Machining Center



With Siemens 840D-SL

U630 Compact available in 3 configurations

- U3-630 Compact:
3-axes-version with fixed table
- U4-630 Compact:
4-axes-version with large rotary table
- U5-630 Compact:
5-axes-version with integrated rotary/tilting table



- Large X stroke with 630 mm or 1530 mm
- Both side bearing for tilting-axis
- THE entry-level machine for 5-axes machining

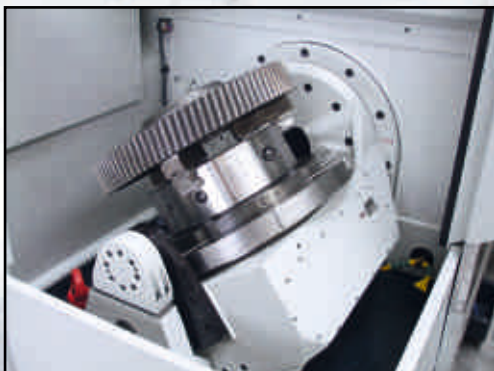

U-Compact

Dynamic
Optimal access
Flexible use

The entry-level machine for 5-axes machining

U1530 Compact available in 3 configurations

- U3-1530 Compact: 3-axes-version with large fixed table
- U4-1530 Compact: 4-axes-version with large rotary table and fixed table on left side in the working area
- U5-1530 Compact: 5-axes-version with integrated rotary/tilting table and fixed table on left side in the working area

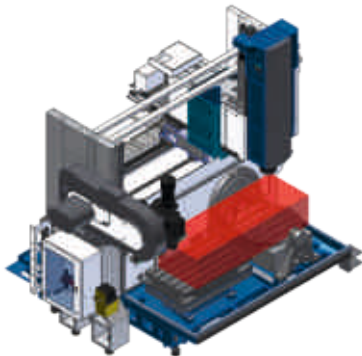
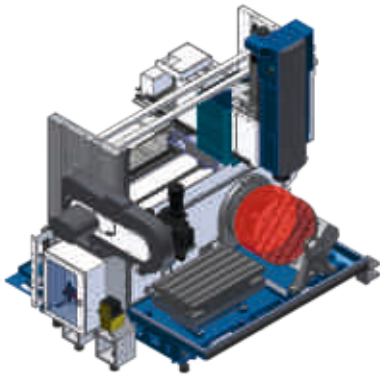

With Heidenhain TNC620



Strokes

	X axis	Y axis	Z axis	B axis
U630	630 mm	530 mm	465 mm	+110°/-90°
U1530	1530 mm	530 mm	465 mm	+110°/-90°

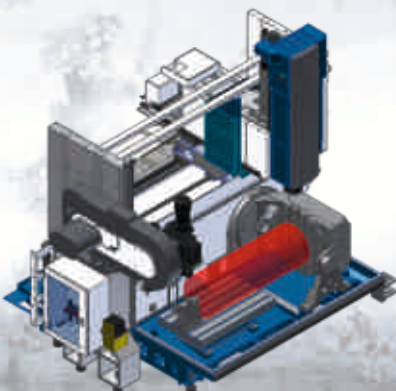

U-Advanced

Professional 5-axes machining
Highly dynamic
Compact and sealed

Travelling-Column Machining Center

U1530 available in 3 configurations

- U3-1530: 3-axes-version with large fixed table
- U4-1530: 4-axes-version with large rotary table and fixed table on left side in the working area
- U5-1530: 5-axes-version with integrated rotary/tilting table and fixed table on left side in the working area



U5-1530 with Siemens 840D-SL and 24-inch Touch panel

- With high-precision rotary/tilting tables available with weight compensation
- Extendable up to 122 tools
- Available with pallet changer
- Most modern control systems: Siemens 840D-SL or Heidenhain TNC640
- With most modern digital drives
- Spindle speeds up to 20.000 rpm



Machining example U4 und U5

U-Advanced

Optimal accuracy
For tool making and mass producer
Optimal ergonomics

For High-End applications

U630 available in 3 configurations

- U3-630: 3-axes-version with fixed table
- U4-630: 4-axes-version with large rotary table
- U5-630: 5-axes-version with integrated rotary/tilting table



U5-630 with Heidenhain TNC640



Strokes

	X axis	Y axis	Z axis	B axis
U630	630 mm	530 mm	465 mm	+180°/-120° ^{1) 2)}
U1530	1530 mm	530 mm	465 mm	+180°/-120° ^{1) 2)}

1) U4 360°
2) +110°/-90° with T-Table

VC-3A

Compact
Highly dynamic
Quick double arm changer

High-Performance Machining Center



VC850 with Siemens 840D-SL and 24-inch Touch panel

- Full cast design with fixed column
- Mass optimised slides for high rapid traverse
- Large sized linear guides and high dynamics
- Spindle speeds between 8.000 and 24.000 rpm, according to the application

User interface of the
24-inch Touch panel



Cast structure VC850



VC-3A

High spindle speeds
Rigid casting machine bed
Powerful

For tool and mould making and HSC machining



Cast structure VC1650

- Innovative guideway cover concept
- Small distance to the working table
- Adjustable control panel
- FEM optimised cast structure



Strokes

	X axis	Y axis	Z axis
VC750/VC750XL	760/950 mm	460 mm	460 mm
VC850	850 mm	510 mm	510 mm
VC1150	1150 mm	620 mm	600 mm
VC1650-3A	1650 mm	820 mm	820 mm



VC-5A

Powerful
Dynamic
Ergonomic

5-Axes High-Precision Machining Centre

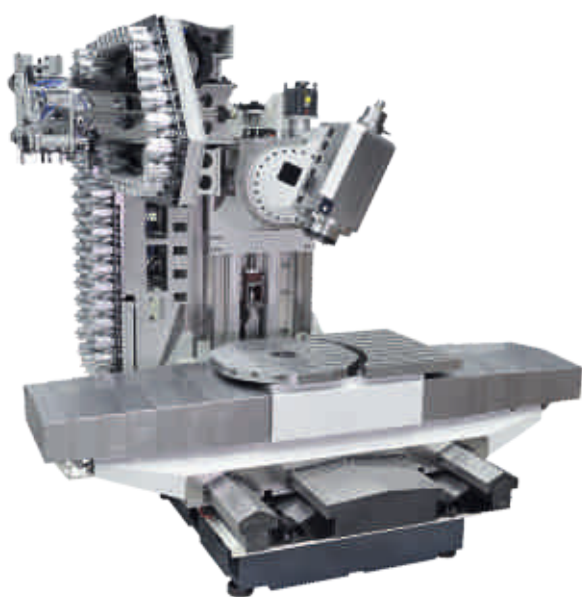

- New and patent-registered guideway cover concept
- Ideal for heavy workpieces
- Additional fixed table for 3-axes machining
- Optimal chip disposal by means of 4 worm conveyors
- Up to 138 tools in the tool magazine



Ergonomic
operating panel
adjustable in
height and angle

Compact
Large workspace
Made in Germany

For large workpieces



- Additional fixed table on the right side in the workspace
- Small distance to the working table



Strokes

	X axis	Y axis	Z axis	Pivot axis B in the milling head
VC1650-5A	1650 mm	820 mm	820 mm	-1° / +110°

Bar feeder

SERVO-LOAD 80 1500

Compact
Fast
Affordable

Short bar feeders



■ CNC-servo axis for smooth move of the bar

■ For material up to 1200 mm

■ Max. bar diameter 80 / 110 mm



	Servo 80-1500	Servo 110-1500
Max. bar length	1500 mm	1500 mm
Bar diameter	6-80 mm	8-110 mm

Compact
Universal
Precise

Universal Toolgrinder

- For turning and milling tools
- For regrinding or producing new tools
- Special geometry quickly available
- Indispensable for every metal cutting workshop
- With quick changer for grinding wheels
- Always the correct grinding wheel in use



Dividing head



Toolholding plate



Swivel holder



Quick-change-device

Automation

Turn-key projects
Individual or standard
Interlinked machines

Fully automated production solutions for large-scale production

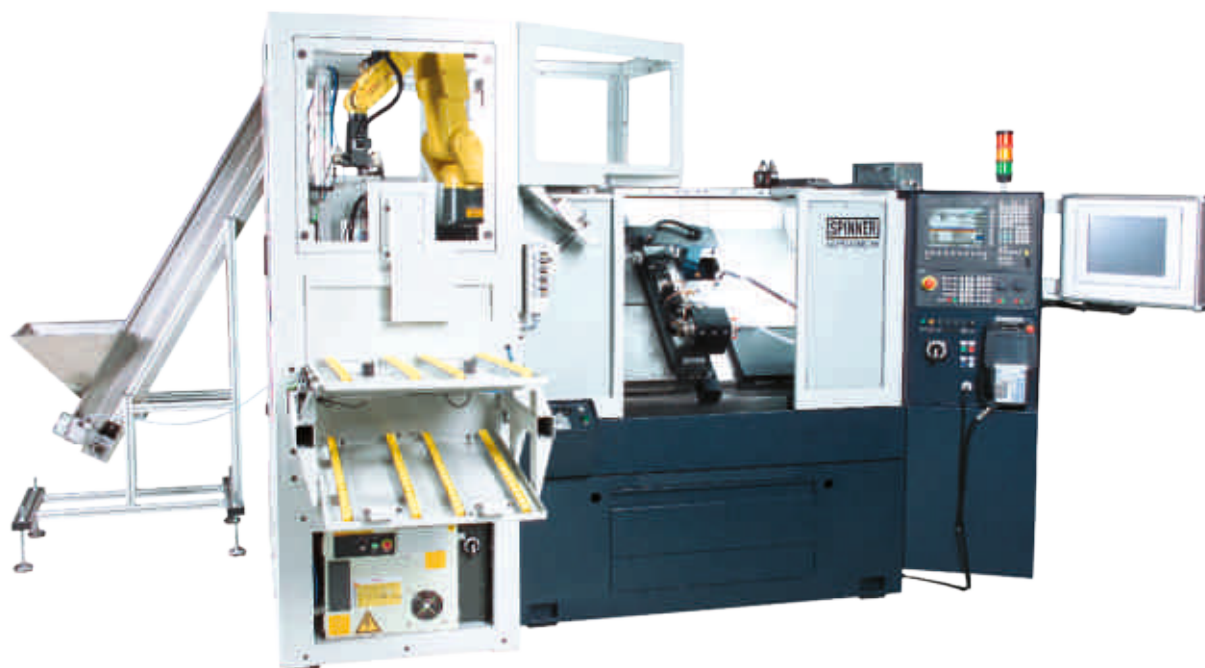

Your advantages at one glance

- Increase in productivity
- Cost reduction
- Optimal processes for your machining requirements
- All with certification according to CE



Automation

Bulk material supply
Integrated or external
Palletising

FROM ONE SINGLE SOURCE, SPINNER and SPINNER-Automation



- Most modern digital drive systems
- Convenient dialogue programming
- With special clamping devices and tools

Ask us for your solution!





Headquarters in Germany:

Rudolf-Diesel-Ring 24
D-82054 Sauerlach
Tel: +49/(0)8104/803-60
Fax: +49/(0)8104/803-19



Factory in Sauerlach



Spinner Türkei



Spinner Automation, Markgröningen

www.spinner.eu.com | sales@spinner.eu.com

Other Spinner factories and representatives

SPINNER TAKIM TEZGAHLARI SAN VE TIC LTD STI

Istanbul Deri Ve End Serbest Bolge Subesi
Desbas Depo Binasi Hasan Yalman Cad No: 2
TR-Tuzla-Istanbul-Turkey, Tel: 00 90/2 16/3 94 21 34,
3 94 21 82 · info@spinner.com.tr



SPINNER Automation GmbH

Elly-Beinhorn-Strasse 4 · 71706 Markgröningen
Tel. 07145/93508-0
sales@spinner-automation.de



SPINNER AG, Schweiz

Hauserstrasse 35 · CH-8451 Kleinandelfingen
Tel. 00 41/52/3 01 21 55
info@spinner-ag.ch



SPINNER- Italia s.r.l.

Via dell'Industria 63 · I-25030 Erbusco (Brescia)
Tel. 00 39/030/7 24 26 34
sales.italia@spinner.eu.com



SPINNER Sales office Russia

Leningradsky Prospekt, 37, corp, 9
office 213-217
125167 MOSCOW / RUSSLAND
Tel. 007 /495/ 6496792
info@spinner-russia.ru



For further questions please contact your regional sales organisation

Regional Dealer

Technical changes of specifications and pictures are subject to change without notice - Pictures can include options, accessories

Version 8.8.2019 (GB)